

600V 40A FieldStop Trench IGBT

Description

The device is designed by advanced FieldStop Trench technology process. This IGBT offer low $V_{CE(sat)}$, high speed switching performance and excellent quality for application such as PFC,UPS, Welder, PV Inverter and other switching applications.

Features

- FieldStop Trench Technology, Positive temperature coefficient
- $V_{CE(sat)}=1.75V@I_C=40A$
- $t_{rr}=50ns$ (typ.)
- High Speed Switching & Low Power Loss
- High Input Impedance

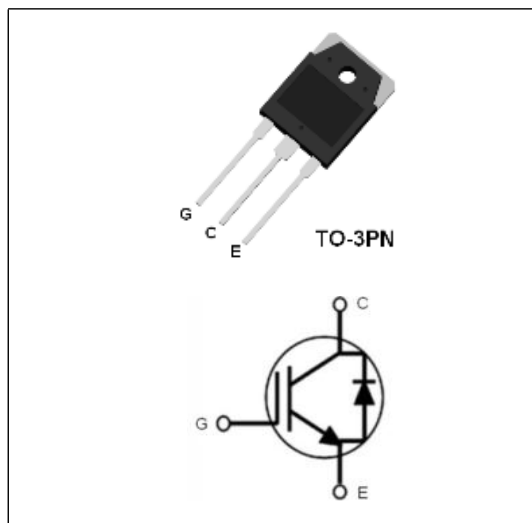

Applications

- PFC, UPS, Welder, PV Inverter

Absolute Maximum Ratings

Symbol	Parameter	Ratings	Unit	
V_{CES}	Collector to Emitter Voltage	600	V	
V_{GES}	Gate to Emitter Voltage	± 20	V	
I_C	Collector Current	$T_C=25^\circ C$	80	A
		$T_C=100^\circ C$	40	A
I_{CM}	Pulsed Collector Current	120	A	
I_F	Diode Continuous Forward Current	$T_C=100^\circ C$	20	A
I_{FM}	Diode Maximum Forward Current	60	A	
P_D	Maximum Power Dissipation	$T_C=25^\circ C$	258	W
		$T_C=100^\circ C$	129	W
T_J	Operating Junction Temperature Range	-40~+175	$^\circ C$	
T_{STG}	Storage Temperature Range	-55~+150	$^\circ C$	

Thermal Characteristics

Symbol	Parameter	Ratings	Unit
$R_{th(J-C)}$ (IGBT)	Thermal Resistance, Junction to case for IGBT	0.58	$^\circ C/W$
$R_{th(J-C)}$ (Diode)	Thermal Resistance, Junction to case for Diode	1.8	$^\circ C/W$
$R_{th(J-A)}$	Thermal Resistance, Junction to Ambient	40	$^\circ C/W$

Electrical Characteristics of IGBT @T_C=25 °C unless otherwise noted

Symbol	Parameter	Conditions	Min.	Typ.	Max.	Unit
BV _{CES}	Collector to Emitter Breakdown Voltage	V _{GE} =0V, I _C =250uA	600	-	-	V
V _{CE(sat)}	Collector to Emitter Saturation Voltage	I _C =40A, V _{GE} =15V	-	1.75	2.2	V
		I _C =40A, V _{GE} =15V, T _C =125°C	-	2.1	-	V
V _{GE(th)}	Gate Threshold Voltage	V _{CE} =V _{GE} , I _C =250uA	4.0	5.1	6.0	V
I _{CES}	Zero Gate Voltage Collector Current	V _{CE} =V _{CES} , V _{GE} =0V	-	-	1	uA
I _{GES}	Gate to Emitter Leakage Current	V _{GE} =V _{GES} , V _{CE} =0V	-	-	± 250	nA

Electrical Characteristics of Diode @T_C=25 °C unless otherwise noted

Symbol	Parameter	Conditions	Min.	Typ.	Max.	Unit
V _F	Diode Forward Voltage	I _F =20A	-	1.5	1.8	V
		I _F =20A, T _C =125°C	-	1.39	-	V
t _{rr}	Diode Reverse Recovery Time	I _F =20A, di/dt=-200A/us	-	50	-	ns
I _{rr}	Diode Peak Reverse Recovery Current		-	6.0	-	A
Q _{rr}	Diode Reverse Recovery Charge		-	100	-	nC

Switching Characteristics @T_C=25 °C unless otherwise noted

Symbol	Parameter	Conditions	Min.	Typ.	Max.	Unit	
t _{d(on)}	Turn-on Delay Time	I _C =40A, V _{CC} =400V, V _{GE} =15V, R _G =7Ω, Inductive Load, T _C =25°C	-	25.2	-	ns	
t _r	Rising Time		-	20.2	-	ns	
t _{d(off)}	Turn-off Delay Time		-	105	-	ns	
t _f	Falling Time		-	18	-	ns	
E _{on}	Turn-on Switching Loss		-	1.29	-	mJ	
E _{off}	Turn-off Switching Loss		-	0.49	-	mJ	
E _{ts}	Total Switching Loss		-	1.78	-	mJ	
t _{d(on)}	Turn-on Delay Time		I _C =40A, V _{CC} =400V, V _{GE} =15V, R _G =7Ω, Inductive Load, T _C =125°C	-	26.8	-	ns
t _r	Rising Time			-	21.2	-	ns
t _{d(off)}	Turn-off Delay Time			-	115	-	ns
t _f	Falling Time	-		22.0	-	ns	
E _{on}	Turn-on Switching Loss	-		1.71	-	mJ	
E _{off}	Turn-off Switching Loss	-		0.52	-	mJ	
E _{ts}	Total Switching Loss	-		2.23	-	mJ	
C _{ies}	Input Capacitance	V _{GE} =0V, V _{CE} =25V, f=1.0MHz		-	1685	-	pF
C _{res}	Reverse Transfer Capacitance			-	74	-	pF
C _{oes}	Output Capacitance			-	48	-	pF
Q _g	Total Gate Charge	I _C =40A, V _{CE} =400V, V _{GE} =15V	-	161	-	nC	
Q _{ge}	Gate to Emitter Charge		-	40	-	nC	
Q _{gc}	Gate to Collector Charge		-	48	-	nC	
tsc	Short Circuit With stand Time	V _{CC} =400V, V _{GE} =15V	-	5	-	us	

Typical Performance Characteristics

Fig. 1. Typical Output Characteristics

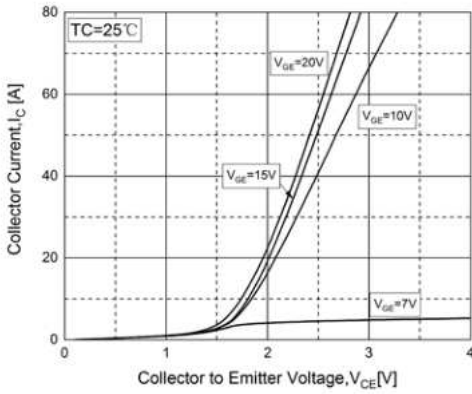

Fig. 2. Typical Saturation Voltage Characteristics

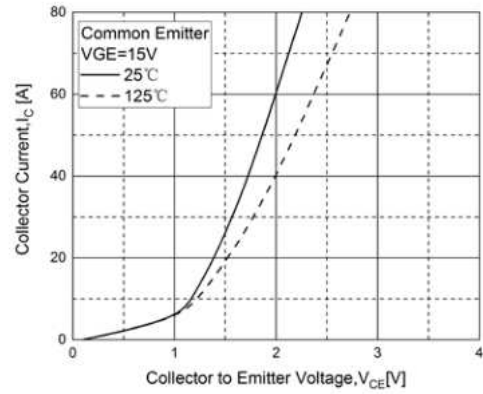

Fig. 3. Typical Saturation Voltage vs. T_C

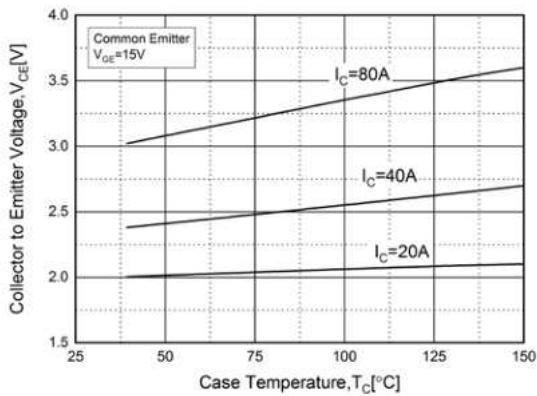

Fig. 4. Diode Forward Characteristics

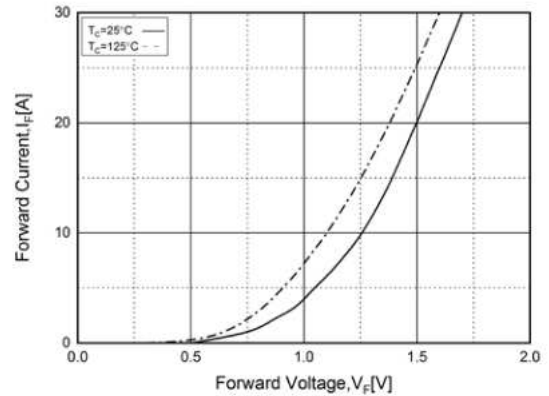

Fig. 5. Typical Capacitance Characteristics

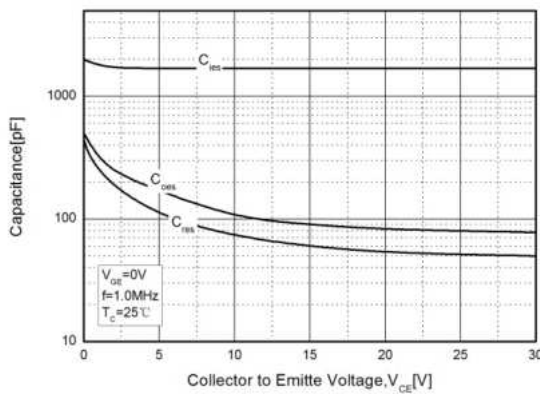
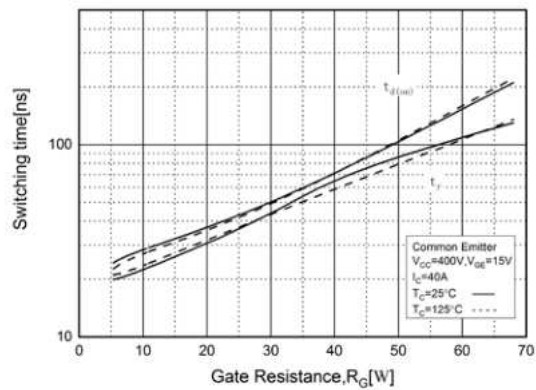

Fig. 6. Turn-on Characteristics vs. R_G



Typical Performance Characteristics

Fig. 7. Turn-off Characteristics vs. R_G

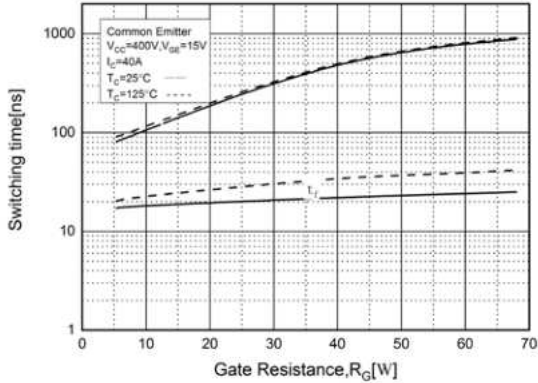

Fig. 8. Switching Loss vs. R_G

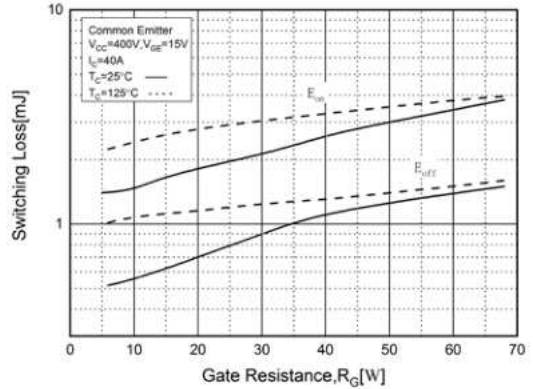

Fig. 9. Turn-on Characteristics vs. I_C

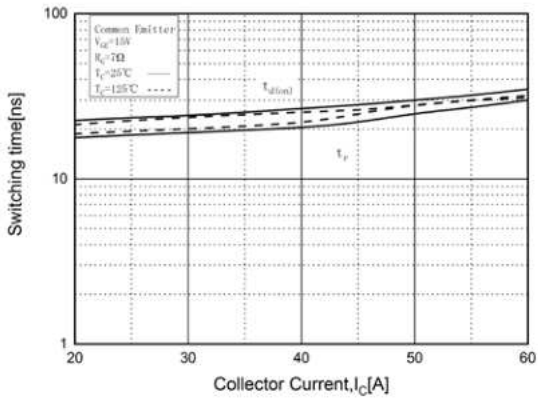

Fig. 10. Turn-off Characteristics vs. I_C

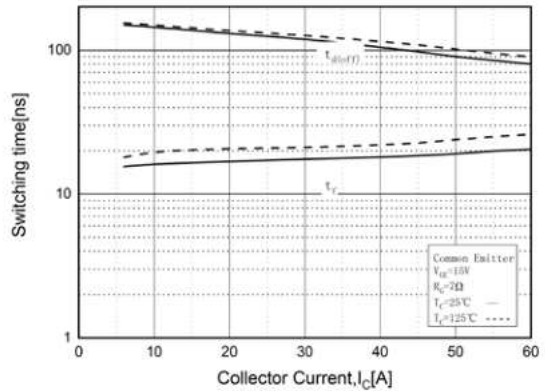
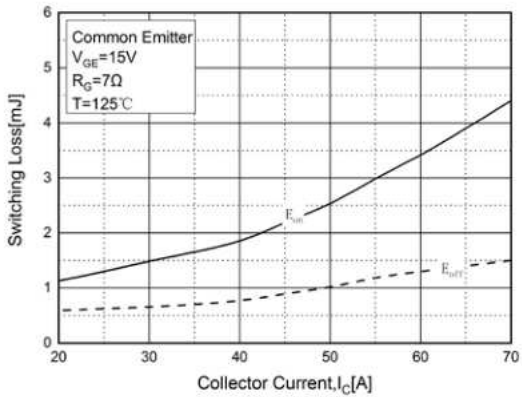

Fig. 11. Switching Loss vs. I_C



Package Dimensions

TO-3PN

(Dimensions in Millimeters)

