

TYN1690/ 1890 Serial 90A SCRs

GENERAL DESCRIPTION:

TYN1690/1890 series of silicon controlled rectifiers, with high ability to withstand the shock loading of large current, provide high dv/dt rate with strong resistance to electromagnetic interference. They are especially recommended for use on solid state relay, motorcycle, power charger, T-tools, etc.

Main Features:

$I_{T(RMS)}$	V_{DRM}/V_{RRM}	I_{GT}
90A	1600V and 1800 V	10 - 80 mA

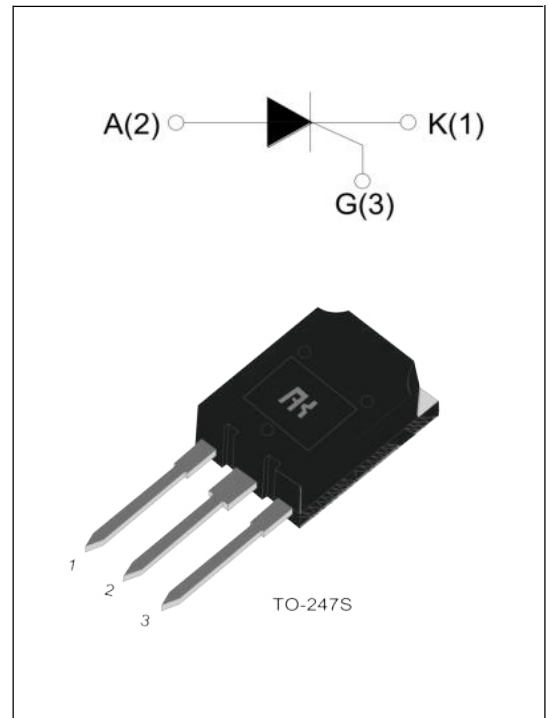

Absolute Ratings(limiting values) :

Symbol	Parameter	Value	Unit	
T_{stg}	Storage junction temperature range	- 40 to + 150	°C	
T_j	Operating junction temperature range	- 40 to + 125	°C	
$I_{T(AV)}$	Average on-state current	TO-247S (TC=80°C)	56	A
$I_{T(RMS)}$	RMS on-state current	TO-247S (TC=80°C)	90	A
I_{TSM}	Non repetitive surge peak on-state current (tp=10ms)	1250	A	
V_{DRM}	Repetitive peak off-state voltage(Tj =25°C)	1600 and 1800	V	
V_{RRM}	Repetitive peak reverse voltage(Tj =25°C)	1600 and 1800	V	
I^2t	I ² t value for fusing tp = 10 ms	7800	A ² s	
dI/dt	Critical rate of rise of on-state current (I _G =2 × I _{GT})	150	A/μs	
I_{GM}	Peak gate current	4	A	

P_{G(AV)}	Average gate power dissipation	1	W
P_{GM}	Peak gate power	5	W

Electrical Characteristics : (T_j=25°C unless otherwise specified)

Symbol	Test Condition	Value			Unit
		MIN	TYP	MAX	
I_{GT}	V _D =12V R _L =30Ω	10	-	80	mA
V_{GT}		--	-	1.5	V
V_{GD}	V _D =V _{DRM} T _j =125°C	0.25	--	--	V
I_L	I _G =1.2 I _{GT}	--	--	200	mA
I_H	I _T = 1A	--	--	150	mA
dv/dt	V _D =2/3V _{DRM} Gate Open T _j =125°C	1000	--	--	V/μs

STATIC CHARACTERISTICS

Symbol	Parameter		Value(MAX)	Unit
V_{TM}	I _{TM} = 100A tp= 380μs	T _j =25°C	1.8	V
I_{DRM} I_{RRM}	V _D =V _{DRM} , V _R =V _{RRM}	T _j =25°C	50	μ A
		T _j =125°C	10	mA

Thermal Resistances :

Symbol	Parameter	Value	Unit
R_{th(j-e)}	junction to case(DC)	TO-247S	0.43 °C/W

FIG.1 Maximum power dissipation versus RMS on-state current

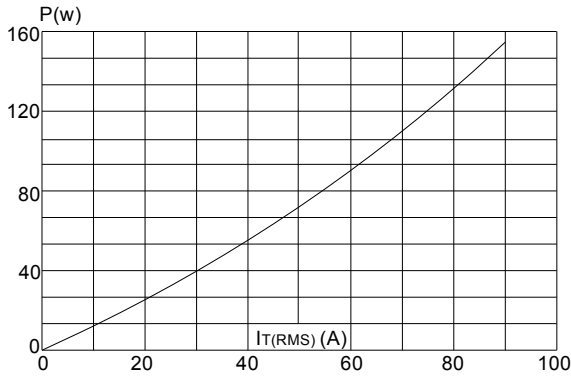

FIG.2: RMS on-state current versus case temperature

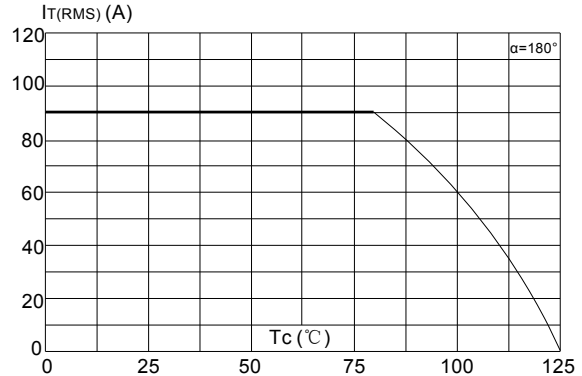

FIG.3: Surge peak on-state current versus number of cycles

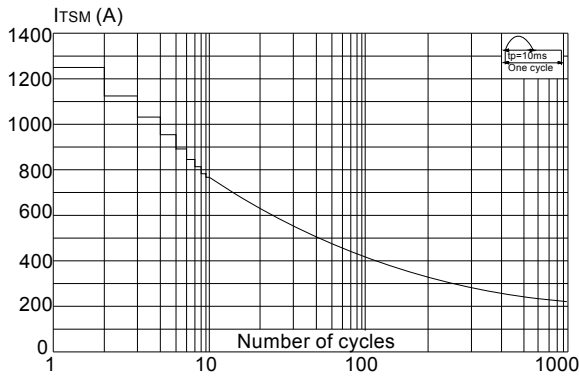

FIG.4: On-state characteristics (maximum values)

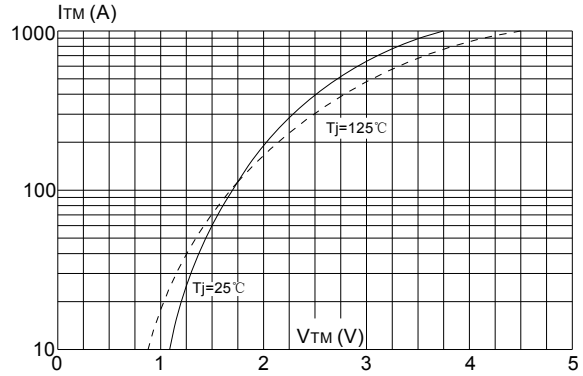

FIG.5: Non-repetitive surge peak on-state current for a sinusoidal pulse with width $t_p < 10\text{ms}$, and corresponding value of I^2t

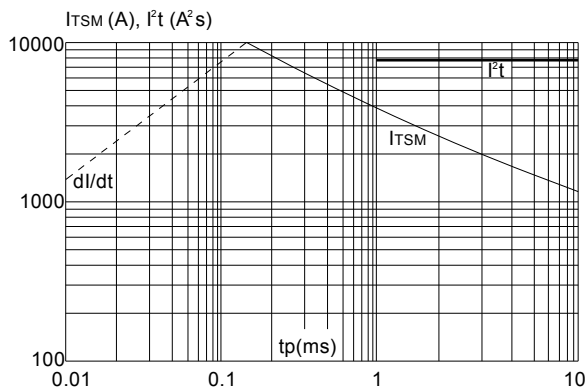
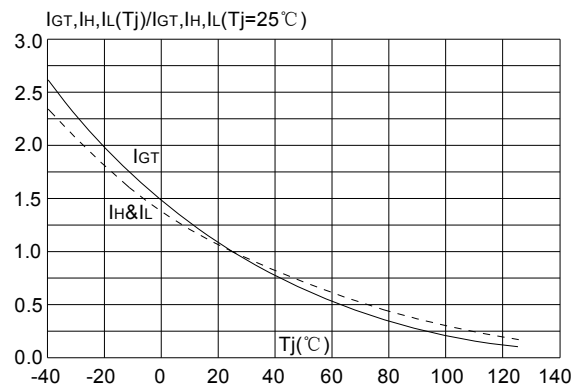
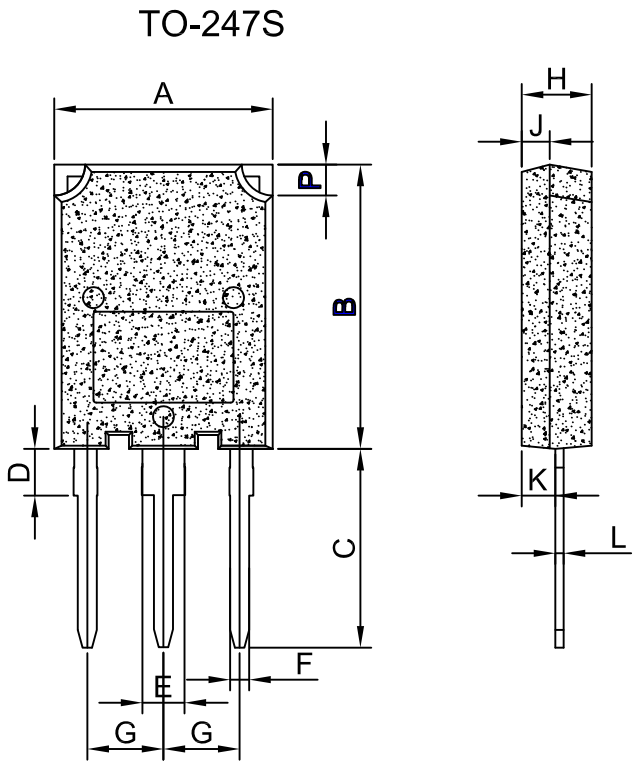

FIG.6: Relative variations of gate trigger current, holding current and latching current versus junction temperature



Package Mechanical Data :



Ref.	Dimensions			
	Millimeters		Inches	
	Min.	Max.	Min.	Max.
A	15.1	16.1	0.595	0.632
B	19.8	20.8	0.78	0.818
C	13.8	14.8	0.544	0.582
D	3.0	4.0	0.118	0.157
E	2.75	3.35	0.108	0.132
F	1.3	1.5	0.051	0.059
G	5.1	5.8	0.201	0.228
H	4.5	5.5	0.178	0.216
J	1.45	2.15	0.058	0.084
K	1.9	2.8	0.075	0.110
L	0.55	0.8	0.022	0.032
P	2	2.4	0.079	0.095

Ordering Information:

