

## TYN1680/1880 Serial 75A SCRs

### GENERAL DESCRIPTION

TYN1680/1880 series of silicon controlled rectifiers, with high ability to withstand the shock loading of large current, provide high dv/dt rate with strong resistance to electromagnetic interference. They are especially recommended for use on solid state relay, motorcycle, power charger, T-tools, etc.

### Main Features:

$I_{T(RMS)}$	$V_{DRM}/V_{RRM}$	$I_{GT}$
75A	1600V and 1800 V	10 - 80 mA

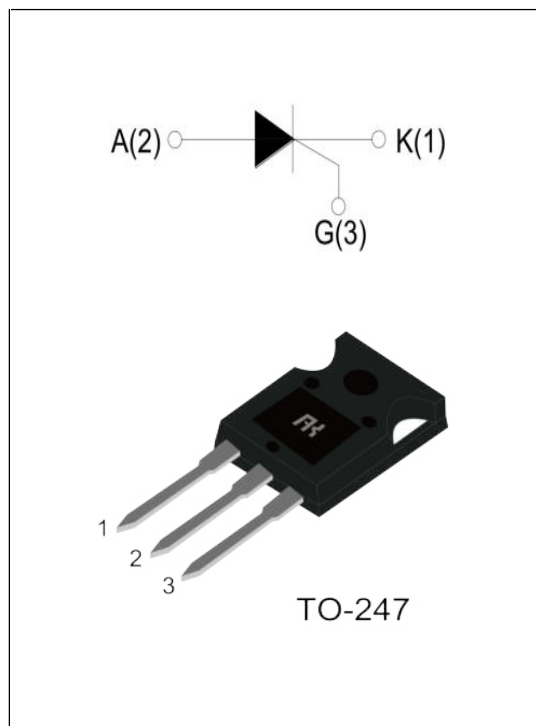

### Absolute Ratings(limiting values) :

Symbol	Parameter		Value	Unit
$T_{stg}$	Storage junction temperature range		- 40 to + 150	°C
$T_j$	Operating junction temperature range		- 40 to + 125	°C
$I_{T(AV)}$	Average on-state current	TO-247 (TC=80°C)	70	A
$I_{T(RMS)}$	RMS on-state current	Lead Current Limitation	75	A
$I_{TSM}$	Non repetitive surge peak on-state current (tp=10ms)		800	A
$V_{DRM}$	Repetitive peak off-state voltage(Tj =25°C)		1600 and 1800	V
$V_{RRM}$	Repetitive peak reverse voltage(Tj =25°C)		1600 and 1800	V
$I^2t$	I <sup>2</sup> t value for fusing tp = 10 ms		5000	A <sup>2</sup> s
$dI/dt$	Critical rate of rise of on-state current (I <sub>G</sub> =2 × I <sub>GT</sub> )		150	A/μs
$I_{GM}$	Peak gate current		2.5	A

<b>P<sub>G(AV)</sub></b>	Average gate power dissipation	2	W
<b>P<sub>GM</sub></b>	Peak gate power	10	W

**Electrical Characteristics : (T<sub>j</sub>=25°C unless otherwise specified)**

Symbol	Test Condition	Value			Unit
		MIN	TYP	MAX	
<b>I<sub>GT</sub></b>	V <sub>D</sub> =12V R <sub>L</sub> =30Ω	10	-	80	mA
<b>V<sub>GT</sub></b>		--	-	1.5	V
<b>V<sub>GD</sub></b>	V <sub>D</sub> =V <sub>DRM</sub> T <sub>j</sub> =125°C	0.25	--	--	V
<b>I<sub>L</sub></b>	I <sub>G</sub> =1.2 I <sub>GT</sub>	--	--	200	mA
<b>I<sub>H</sub></b>	I <sub>T</sub> = 1A	--	--	150	mA
<b>dv/dt</b>	V <sub>D</sub> =2/3V <sub>DRM</sub> Gate Open T <sub>j</sub> =125°C	1000	--	1000	V/μs

**STATIC CHARACTERISTICS**

Symbol	Parameter		Value(MAX)	Unit
<b>V<sub>TM</sub></b>	I <sub>TM</sub> = 100A tp= 380μs	T <sub>j</sub> =25°C	1.55	V
<b>I<sub>DRM</sub></b> <b>I<sub>RRM</sub></b>	V <sub>D</sub> =V <sub>DRM</sub> , V <sub>R</sub> =V <sub>RRM</sub>	T <sub>j</sub> =25°C	50	μ A
		T <sub>j</sub> =125°C	10	mA

**Thermal Resistances :**

Symbol	Parameter		Value	Unit
<b>R<sub>th(j-c)</sub></b>	junction to case(DC)	TO-247	0.32	°C/W

Fig.1: Maximum power dissipation versus RMS on-state current versus case temperaturecurrent Fig.2 : RMS on-state current versus case temperaturecurrent

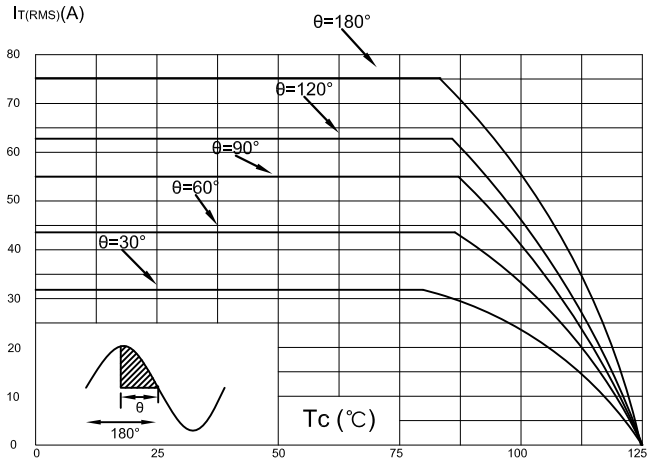
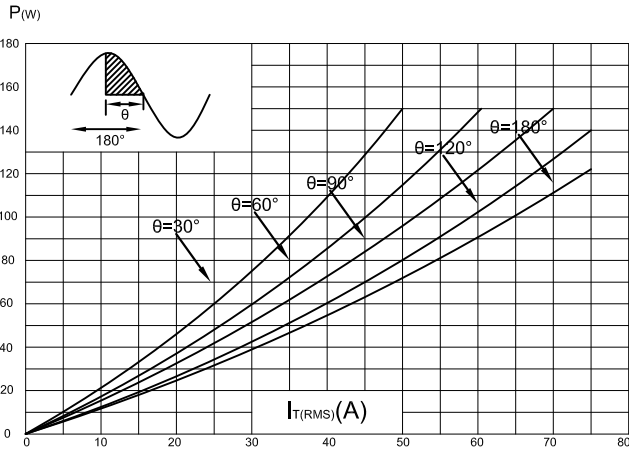

Fig.3 : Surge peak on-state current versus number of cycles Fig.4 : On-state characteristics (maximum values)

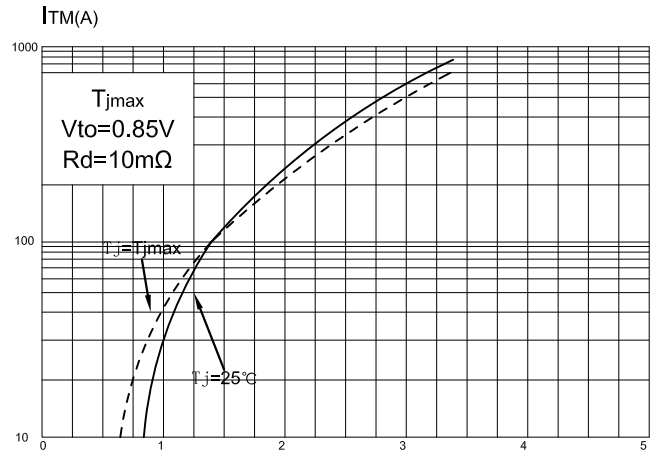
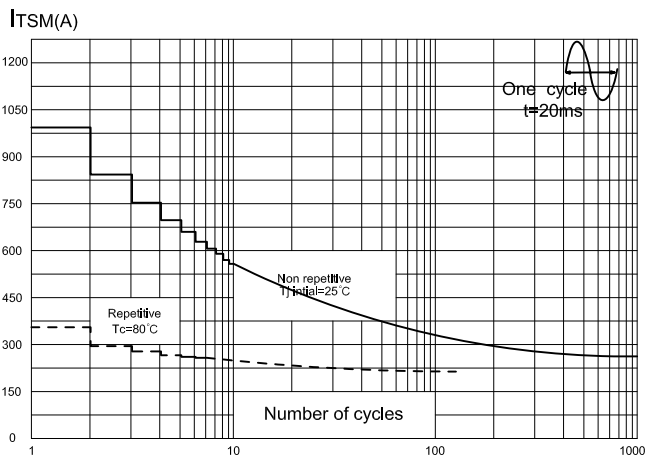

Fig.5 : Non-repetitive surge peak on-state current for a sinusoidal pulse with width  $t_p < 10ms$  and corresponding value of  $I^2 t$  ( $di/dt < 50A/\mu s$ )

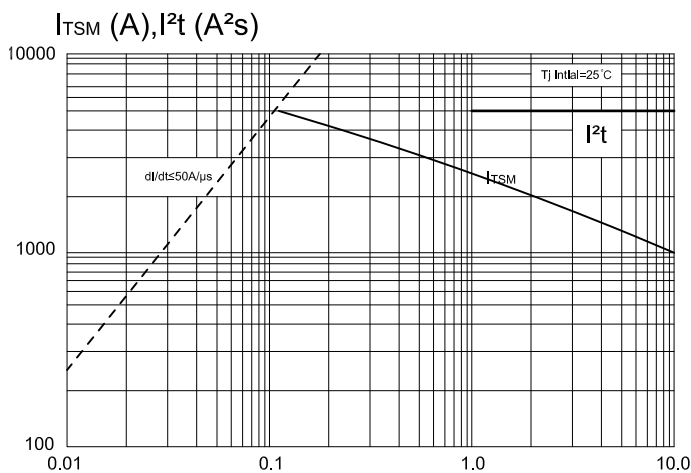
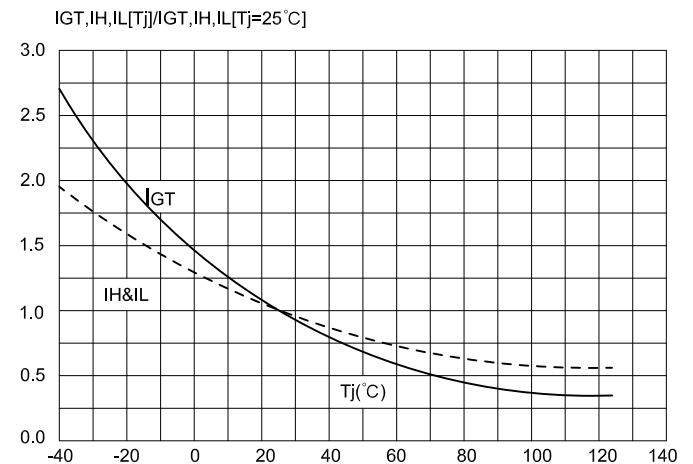
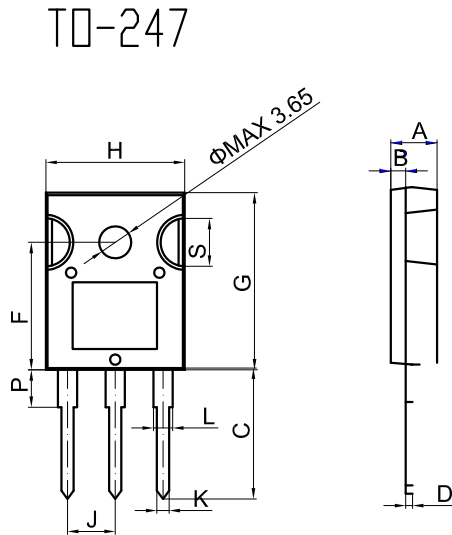

Fig.6: Relative variations of gate trigger current versus junction temperature



**Package Mechanical Data :**



Ref.	Dimensions					
	Millimeters			Inches		
	Min.	Typ.	Max.	Min.	Typ.	Max.
A	4.9		5.4	0.193		0.213
B	1.6		2.0	0.063		0.079
C	14.35		15.4	0.565		0.606
D	0.5		0.8	0.020		0.031
F	14.4		15.1	0.567		0.594
G	19.7		20.6	0.775		0.811
H	15.4		16.2	0.606		0.638
J	5.3		5.6	0.209		0.220
K	1.3		1.5	0.051		0.059
L	2.8		3.3	0.110		0.130
P	3.7		4.2	0.146		0.165
S	5.35		5.65	0.211		0.222

**Ordering Information:**

