

2P4M Serial Sensitive Gate SCRS

GENERAL DESCRIPTION :

The 2P4M SCR series provide high dv/dt rate with strong resistance to electromagnetic interface. They are especially recommended for use on residual current circuit breaker, straight hair, igniter etc.

Main Features:

$I_{T(RMS)}$	V_{DRM}/V_{RRM}	I_{GT}
2A	400/600 V	$\leq 200\mu A$

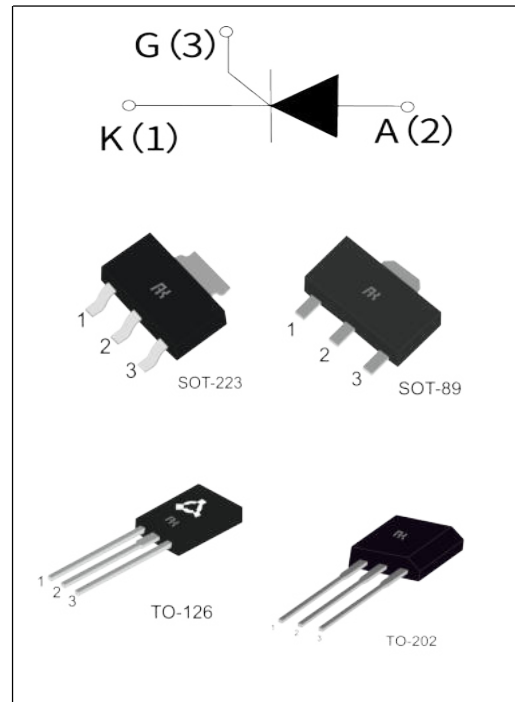

Absolute Ratings(limiting values) :

Symbol	Parameter		Value	Unit
T_{stg}	Storage junction temperature range		- 40 to + 150	$^{\circ}C$
T_j	Operating junction temperature range		- 40 to + 110	$^{\circ}C$
$I_{T(RMS)}$	RMS on-state current	TO-202 (TC=90 $^{\circ}C$)	2	A
		SOT-89/SOT-223 (TC=70 $^{\circ}C$)		
		TO-126 (TC=80 $^{\circ}C$)		
I_{TSM}	Non repetitive surge peak on-state current (tp=10ms)		20	A
V_{DRM}	Repetitive peak off-state voltage(Tj =25 $^{\circ}C$)		400/600	V
V_{RRM}	Repetitive peak reverse voltage(Tj =25 $^{\circ}C$)		400/600	V
V_{DSM}	Non repetitive surge peak Off-state voltage		$V_{DRM} + 100$	V
V_{RSM}	Non repetitive peak reverse voltage		$V_{RRM} + 100$	V
I^2t	I^2t value for fusing tp = 10 ms		2	A ² s
dI/dt	Critical rate of rise of on-state current		50	A/ μs

I_{GM}	Peak gate current (tp=20 μ s, T _j =110°C)	0.2	A
P_{G(AV)}	Average gate power dissipation (tp=20 μ s, T _j =110°C)	0.1	W
P_{GM}	Peak gate power (T _j =110°C)	0.5	W

Electrical Characteristics : (T_j=25°C unless otherwise specified)

Symbol	Test Condition	Value			Unit
		MIN	TYP	MAX	
I_{GT}	V _D =12V R _L =33Ω	--	50	200	μA
V_{GT}		--	0.6	0.8	V
V_{GD}	V _D =V _{DRM} R _L =3.3kΩ T _j =110°C	0.2	--	--	V
I_L	I _G =1.2 I _{GT}	--	--	6	mA
I_H	I _T = 50mA	--	--	5	mA
dV/dt	V _D =2/3V _{DRM} T _j =110°C R _{GK} =1kΩ	10	--	--	V/μs

Static Characteristics

Symbol	Parameter		Value(MAX)	Unit
V_{TM}	I _{TM} = 4A tp= 380μs	T _j =25°C	1.5	V
I_{DRM} I_{RRM}	V _D =V _{DRM} , V _R =V _{RRM}	T _j =25°C	5	μ A
		T _j =110°C	100	μ A

Thermal Resistances :

Symbol	Parameter		Value	Unit
R_{th(j-c)}	junction to case(AC)	TO-126\TO-202	6.5	°C/W
		SOT-223	20	
		SOT-89	25	

Fig.1: Maximum power dissipation versus RMS on-state current

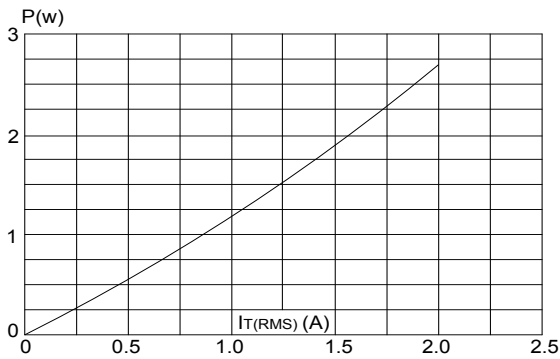

Fig.2 : RMS on-state current versus case temperature

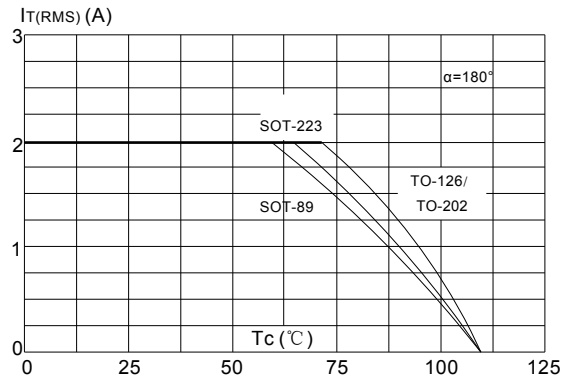

Fig.3 : Surge peak on-state current versus number of cycles

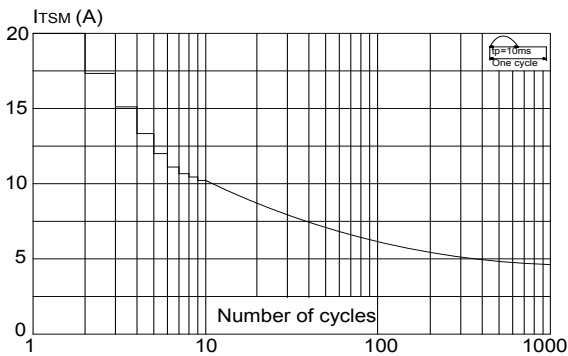

Fig.4 : On-state characteristics (maximum values)

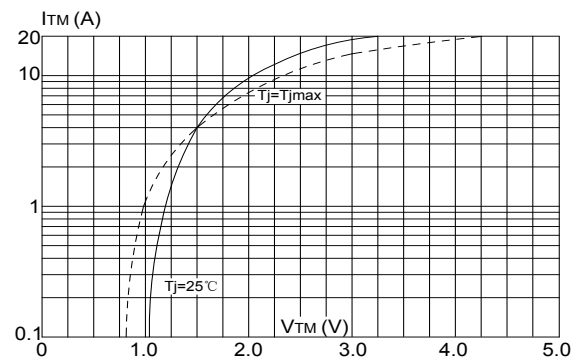

Fig.5 : Non-repetitive surge peak on-state current for a sinusoidal pulse with width $t_p < 10ms$ and corresponding value of $I^2 t$ ($di/dt < 50A/\mu s$)

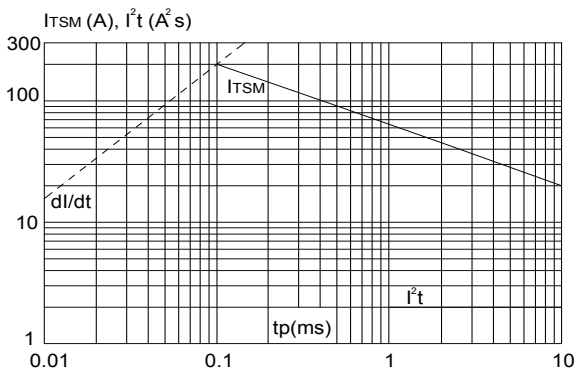
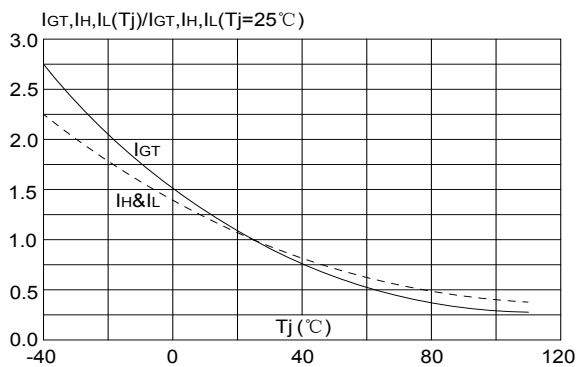
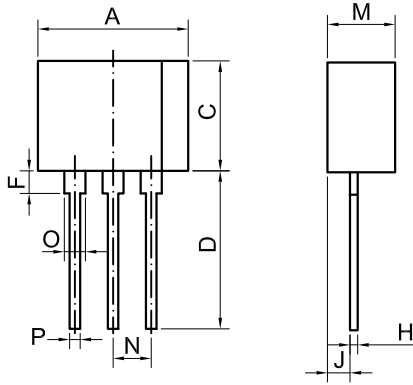

Fig.6: Relative variations of gate trigger current, holding current and latching current versus junction temperature



Package Mechanical Data :

TO-202-3



Ref.	Dimensions					
	Millimeters			Inches		
	Min.	Typ.	Max.	Min.	Typ.	Max.
A	9.30		9.90	0.366		0.390
C	7.0		7.6	0.276		0.299
D	10.5		11.5	0.413		0.453
F	1.50		2.50	0.059		0.098
H	0.45		0.55	0.018		0.022
J	1.50		1.90	0.059		0.075
M	4.40		4.70	0.173		0.185
N		2.54			0.100	
O	1.20		1.50	0.047		0.059
P	0.60		0.80	0.024		0.031

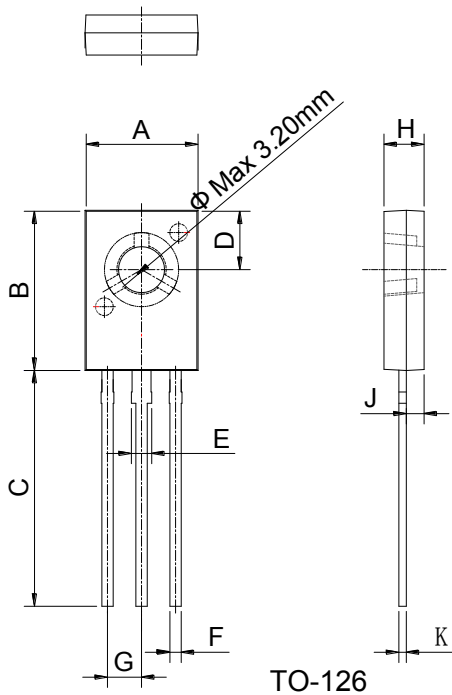

Ref.	Dimensions					
	Millimeters			Inches		
	Min.	Typ.	Max.	Min.	Typ.	Max.
A	7.40		7.80	0.291		0.307
B	10.6		11.2	0.417		0.441
C	15.3		16.3	0.602		0.642
D	3.90		4.10	0.154		0.161
E	1.17		1.47	0.046		0.058
F	0.66		0.86	0.026		0.034
G		2.29			0.090	
H	2.50		2.90	0.098		0.114
J	1.10		1.50	0.043		0.059
K	0.45		0.60	0.018		0.024

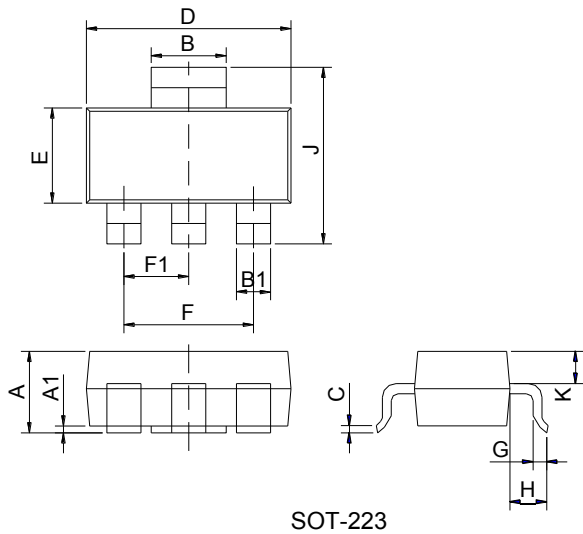

Ref.	Dimensions					
	Millimeters			Inches		
	Min.	Typ.	Max.	Min.	Typ.	Max.
A	1.5	1.6	1.8	0.059	0.063	0.071
A1	0.01	0.06	0.10	0.001	0.002	0.004
B	2.9	3.0	3.1	0.114	0.118	0.122
B1	0.6	0.7	0.8	0.024	0.028	0.031
C	0.22	0.26	0.32	0.009	0.010	0.013
D	6.3	6.5	6.7	0.248	0.256	0.264
E	3.3	3.5	3.7	0.130	0.138	0.146
F		4.6			0.181	
F1		2.3			0.091	
G	0.7	0.9	1.1	0.028	0.035	0.043
H	1.5	1.75	2	0.059	0.069	0.079
J	6.7	7.0	7.3	0.264	0.276	0.287
K		0.9			0.035	

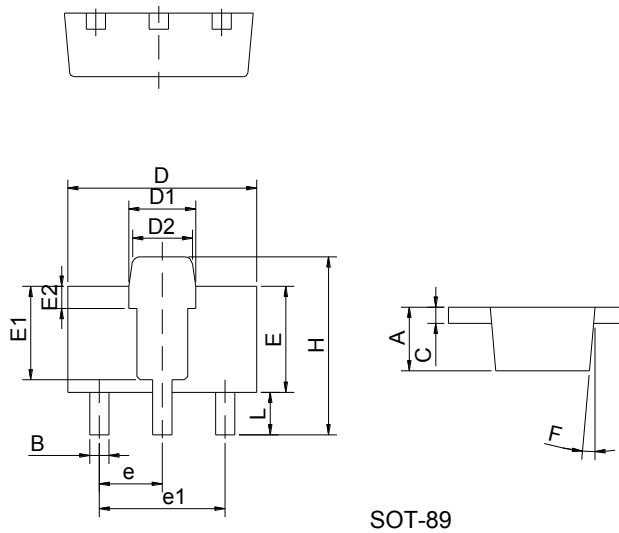

Ref.	Dimensions					
	Millimeters			Inches		
	Min.	Typ.	Max.	Min.	Typ.	Max.
A	1.40		1.60	0.055		0.063
B	0.40		0.52	0.016		0.020
C	0.35		0.41	0.014		0.016
D	4.40		4.60	0.173		0.181
D1	1.50		1.70	0.059		0.067
D2	1.30		1.50	0.051		0.059
E	2.40		2.60	0.094		0.102
E1		2.20			0.087	
E2		0.52			0.020	
e		1.50			0.059	
e1		3.00			0.118	
F		5°			0.197°	
H	4.05		4.25	0.159		0.167
L	0.89		1.20	0.035		0.047